

3.0mm WAFER 2 ROWS RIGHT ANGLE / STRAIGHT TYPE

SPECIFICATIONS

Current Rating: 5A AC,DC
 Voltage Rating: 250V AC,DC
 Temperature Range: -25°C ~ +85°C
 Contact Resistance: 10mΩ Max
 Insulation Resistance: 1000MΩ Min
 Withstanding Voltage: 1500V AC/minute
 Pin Material: Brass/Tin-plated
 Material: PBT30%GF,UL94V-0
 Color: Natural(Black)

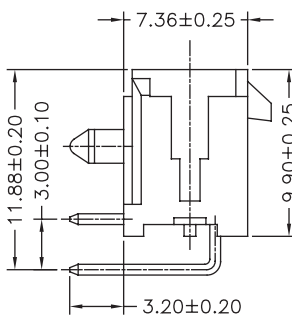
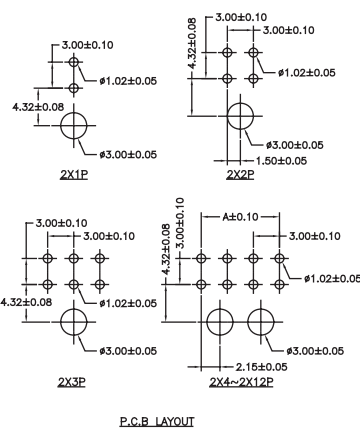
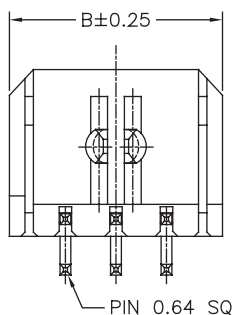
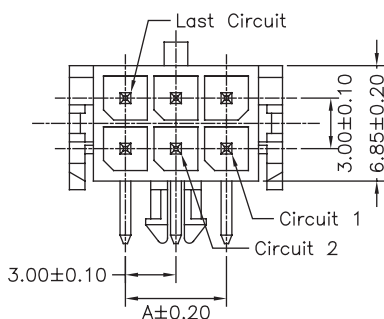
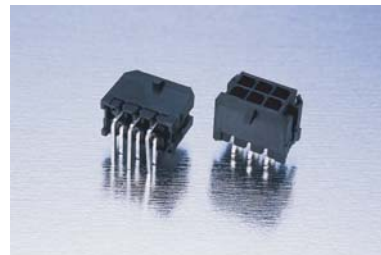

Part No.:3000R-2XXTB-L

PART NO.	Dimensions	
	A	B
3000R-201TB-L	---	6.65
3000R-202TB-L	3.00	9.65
3000R-203TB-L	6.00	12.65
3000R-204TB-L	9.00	15.65
3000R-205TB-L	12.00	18.65
3000R-206TB-L	15.00	21.65
3000R-207TB-L	18.00	24.65
3000R-208TB-L	21.00	27.65
3000R-209TB-L	24.00	30.65
3000R-210TB-L	27.00	33.65
3000R-211TB-L	30.00	36.65
3000R-212TB-L	33.00	39.65

SPECIFICATIONS

Current Rating: 5A AC,DC
 Voltage Rating: 250V AC,DC
 Temperature Range: -25°C ~ +85°C
 Contact Resistance: 10mΩ Max
 Insulation Resistance: 1000MΩ Min
 Withstanding Voltage: 1500V AC/minute
 Pin Material: Brass/Tin-plated
 Material: PBT30%GF,UL94V-0
 Color: Natural(Black)

PART NO.	Dimensions	
	A	B
3000S-201TB-L	---	6.65
3000S-202TB-L	3.00	9.65
3000S-203TB-L	6.00	12.65
3000S-204TB-L	9.00	15.65
3000S-205TB-L	12.00	18.65
3000S-206TB-L	15.00	21.65
3000S-207TB-L	18.00	24.65
3000S-208TB-L	21.00	27.65
3000S-209TB-L	24.00	30.65
3000S-210TB-L	27.00	33.65
3000S-211TB-L	30.00	36.65
3000S-212TB-L	33.00	39.65

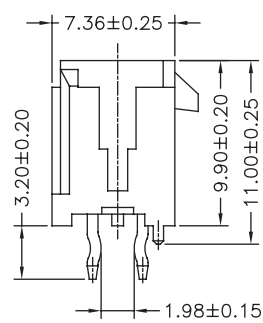
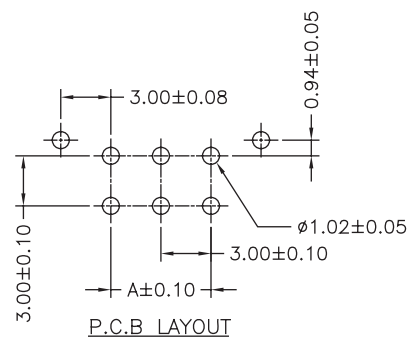
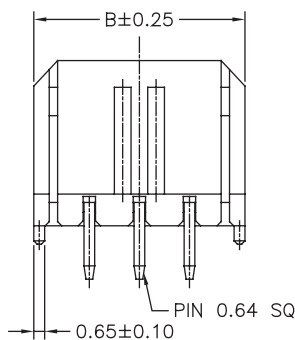
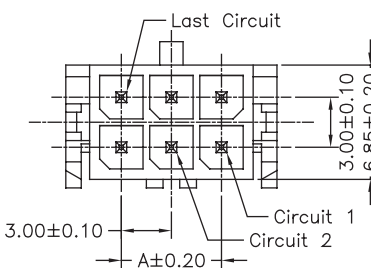

Part No.:3000S-2XXTB-L